

Electronic Combination Cam Lock "Marc"

Available in Vertical (V) and Horizontal (H) version



Userguide

Introduction.....	2
Battery installation.....	2
Private use instructions.....	2-3
Public use instructions.....	3
Alarm function.....	4
Installation instructions.....	4-5
Trouble shooting.....	5
Change battery.....	5
Dimensions.....	5

Electronic Combination Cam Lock "Marc"

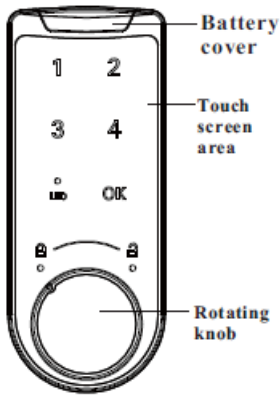

Introduction

- 1-8 digit user code
- 87,380 possible codes
- User code is stored when battery power is lost or removed
- One year battery life
- Short warning tone for low battery
- Tampering alarm

Application:

Wood and Metal materials from 0.6mm-22mm

Function:

- Standard use - Enter user code and it remains until reset.
- One time use - Enter user code to lock and unlock only once.

Battery Installation

1. Slide battery cover open and place battery in holder

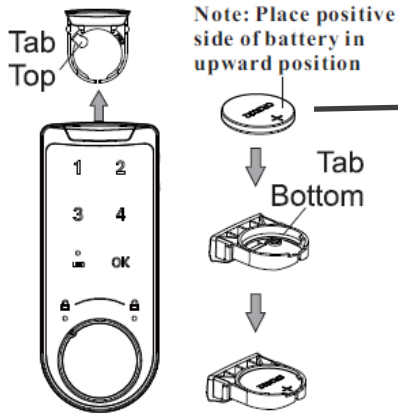

2. Confirm proper battery installation

- Press numbers on touch pad
- Listen for "BEEP" tone
- Look for LED indicator light

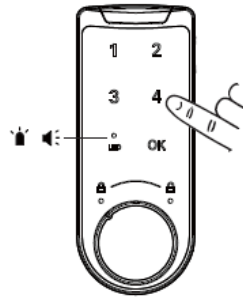

Battery Type: **CR 2032**



Instructions **Private** use (14.60.391)

Factory default code is 123123

1) Unlock

1. Key in 123123 then "OK"
listen for long "BEEP"

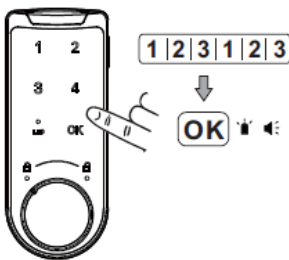

2. Turn knob clockwise to "🔓" position. Lock is now unlocked.

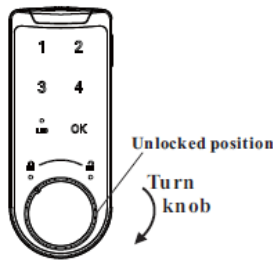

2) Lock

1. Turn knob counter clockwise to "🔒" locked position

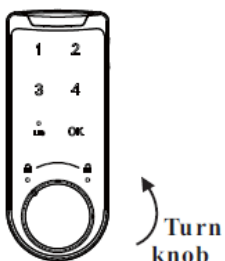

2. Knob is now in a fixed locked position

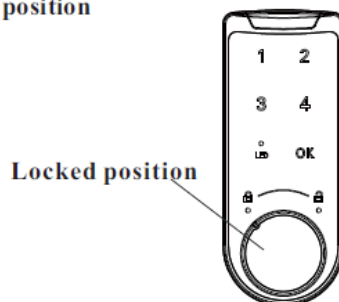

Electronic Combination Cam Lock "Marc"

Instructions **Private** use (14.60.391)

Code Setting (Can be set 1-8 digits long)

Example:

Change factory default code "123123" into new code "12341234"

1. Enter code 1-2-3-1-2-3
Press OK + OK (OK x 2)
Enter new code 1-2-3-4-1-2-3-4
Press OK (OK x 1),
Listen for longer "BEEP" tone

2. Code is now reset
1 2 | 3 4 | 1 2 | 3 4 = ✓

12341234
-Remember
-Securely store new code

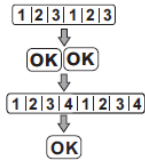
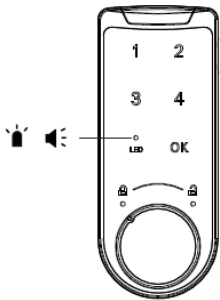

Forgot your code?

For Private version:

Enter Mastercode "xxxxxxx" then press OK button. Wait for 2 seconds and the lock is reset to factory status.

Use now the factory default user code 123123 + OK button and then turn the knob.

You can now set your personal code.

For Mastercode, please contact your furniture supplier.

Instructions **Public** use (14.60.390)

Factory default code is 123123

1) Unlock

1. Key in 123123 listen for long "BEEP"

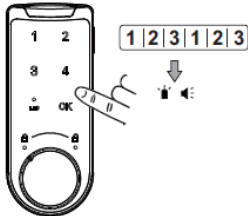

2. Turn knob clockwise to "🔓" position. Lock is now unlocked.

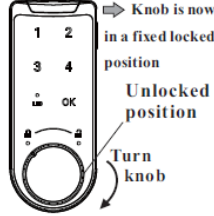

3) Unlock

1. Key in 321321 listen for long "BEEP"

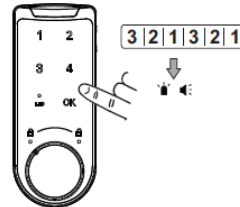

2. Turn knob clockwise to "🔓" position. Lock is now unlocked.

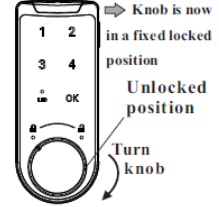

NOTE: Code is good for one use only. Repeat process for new code

2) Lock - Set new code -CODE SETTING MUST BE 6 DIGITS LONG

1. Key in new code 321321

Listen for long "BEEP"

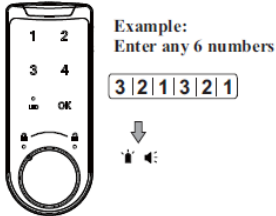

2. Turn knob counter clockwise to "🔒" locked position.

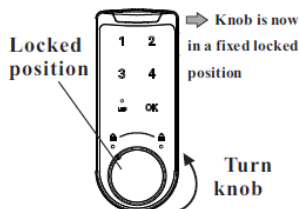

Forgot your code?

For Public version:

Enter Mastercode "xxxxxxx" then press OK button. Wait for 2 seconds and the lock is reset to factory status.

Use now the factory default user code 123123 + OK button and then turn the knob.

The lock is now ready for use.

For Mastercode, please contact your furniture supplier.

Electronic Combination Cam Lock "Marc"

Alarm Function

1. Continuous alarm sounds for 60 seconds when code is incorrectly entered 4 times.

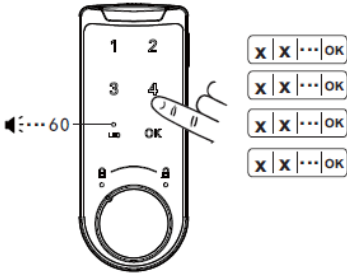

2. Enter correct code to silence the alarm.

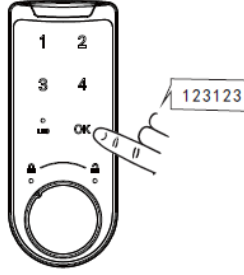

Note:

- Power is supplied by a button cell battery (Model CR2032) with an expected operating life of 1 year with normal usage.
- Three consecutive "BEEP, BEEP, BEEP" tones will indicate low battery life when correct code is entered.
- 200 operating cycles remain when "BEEP, BEEP, BEEP" tone begins.
- Replace battery to ensure proper operation of lock and before the lock becomes inoperable.

Installation instructions vertical set up

1. Drill holes

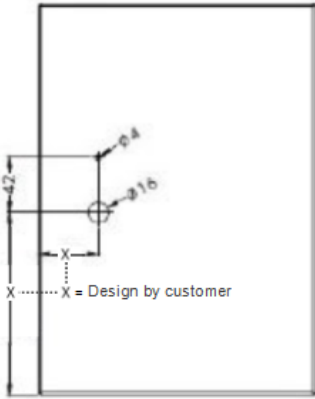

2. Install lock with supplied hardware

- M3.5 flanged screw
- 1 Large nut

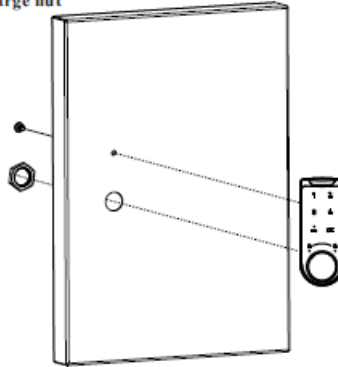

⚠ ATTENTION !!!! IMPORTANT !!!

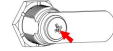

1. Installation of the lock ONLY to be made when the turning knob is in **locked position**
2. Do NOT use torque strength higher than **5.5Kgf.cm**
3. Don't use electric power tools to install the cam plate screw. Use **ONLY** a manual screwdriver.

Installation instructions horizontal set up

1. Drill holes

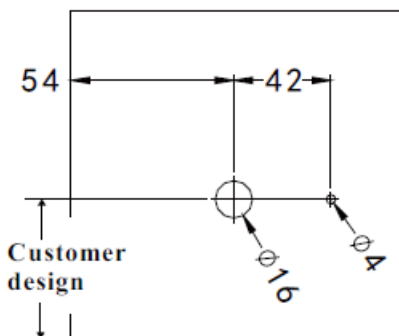

2. Install lock with supplied hardware

- M3.5 flanged screw
- 1 Large nut

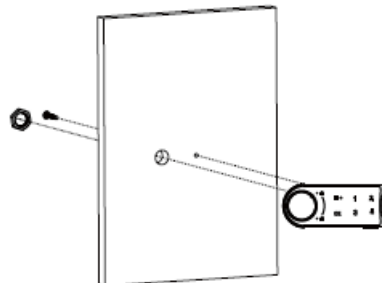

Electronic Combination Cam Lock "Marc"

Installation instructions cam and screws

3. Install supplied CAM and screws

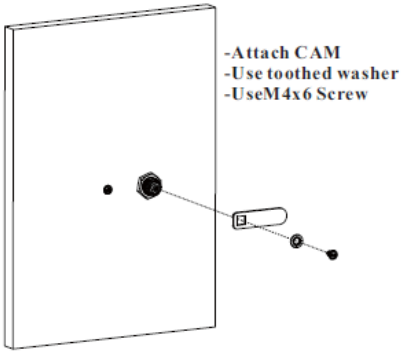

4. Install L-type strike plate using supplied screws

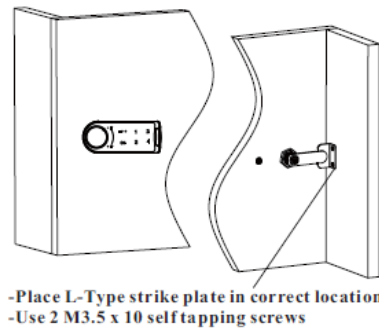

⚠ ATTENTION !!!! IMPORTANT !!!

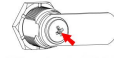

1. Installation of the lock ONLY to be made when the turning knob is in **locked position**
2. Do NOT use torque strength higher than **5.5Kgf.cm**
3. Don't use electric power tools to install the cam plate screw. Use ONLY a manual screwdriver.

Trouble shooting

ISSUE	CAUSE	FIX
Alarm continues to sound after code has been entered 3 times	Wrong code	Enter correct code
1. When pressing buttons -No alarm -No sound 2. Three beeps occur after correct code is entered 3. Lock cannot be open	Low power	Change battery

Change battery

1. Battery change required when "BEEP, BEEP, BEEP" sounds three times after unlocking

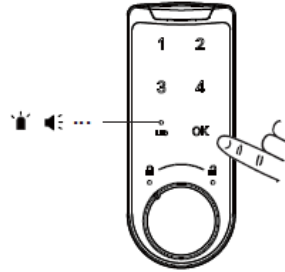

2. Follow below steps to change the battery

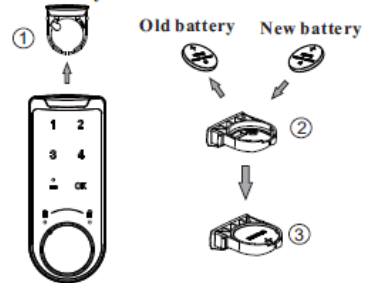

Dimensions

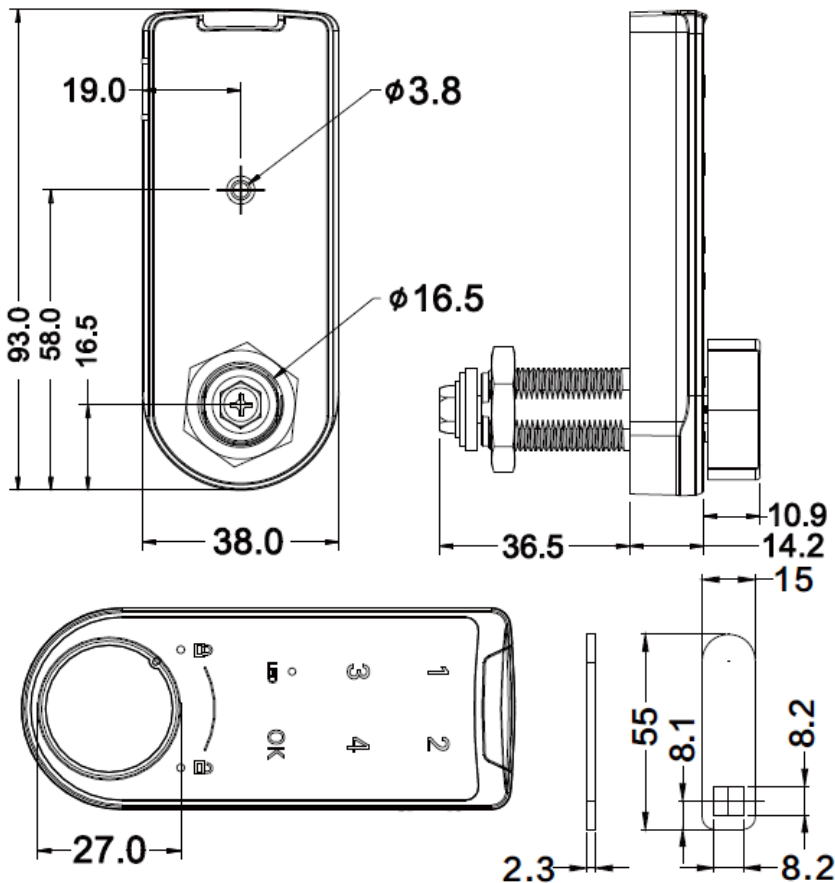

Reset Button

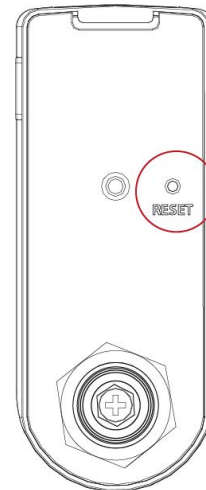

1. Lock can be reset by pushing a small pin into the reset hole.
2. Reset function only works when the turning knob is in closed/locked position.
3. When lock is reset the master code will change to 1234+Ok.
4. To change back to your "Old" master code or "New" master code you have to push 1234+Ok+Ok+Ok+ (Old/New code) + Ok.